

SEPTISCHE PUT 1.500 L. - 4 IE. FOSSE SEPTIQUE 1.500 L. - 4 EH.

BOVENAANZICHT

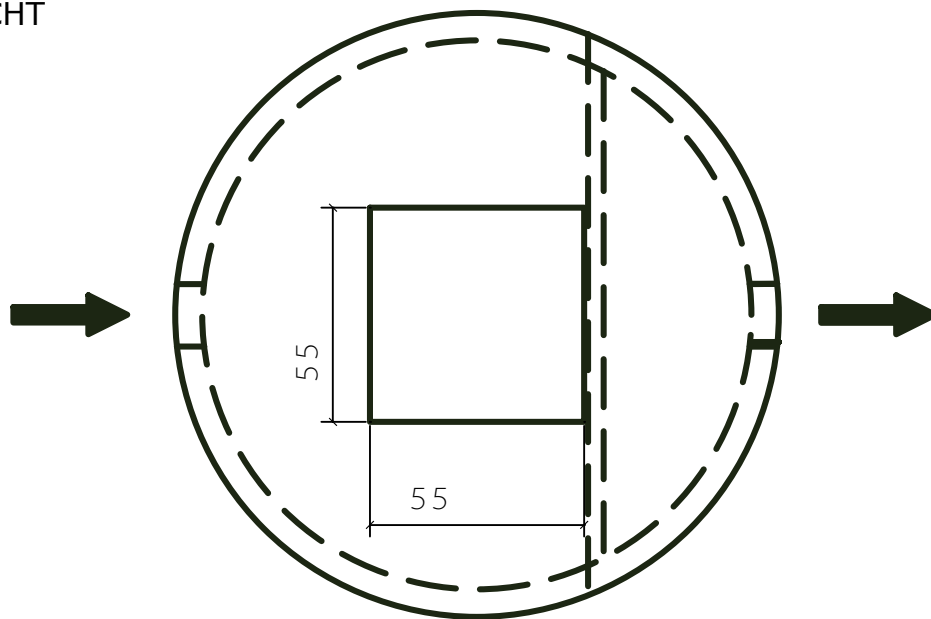

DOORSNEDE

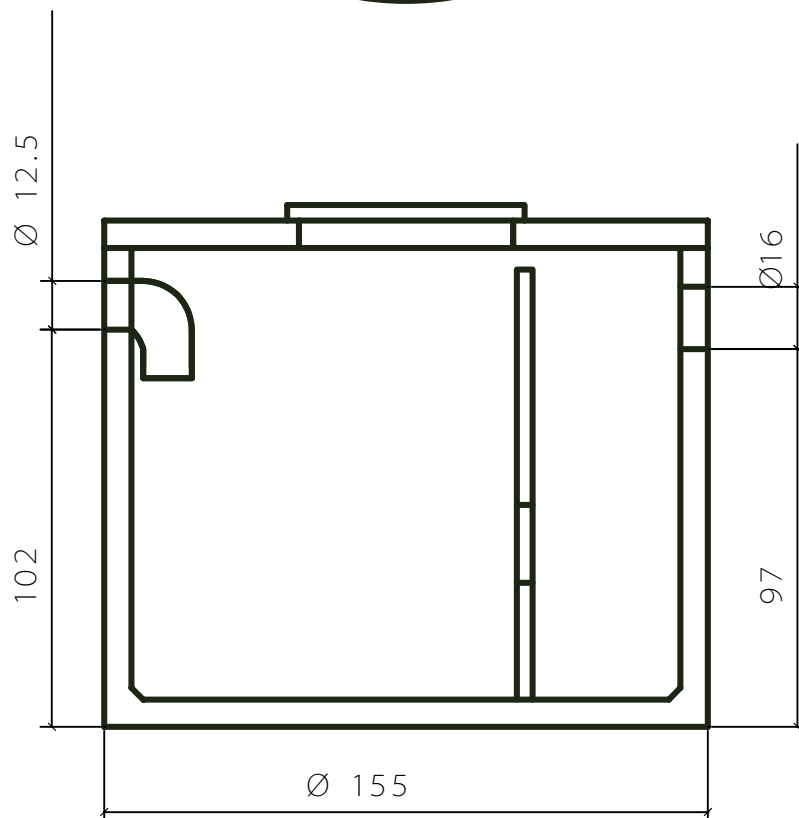

GEWICHT / POIDS : 1440 Kg.

nv AANNEMINGEN FRANS VANDEN BROUCKE sa

BEVERENSTRAAT 46
8540 DEERLIJK
TEL : 056/71.33.01
FAX : 056/70.47.50
info@vandenbrouckefrans.be

ROUTE PROVINCIALE 211
7760 ESCANAFFLES
TEL : 069/45.42.31
FAX : 069/45.63.68
www.vandenbrouckefrans.be